

B&B
ITALIA

design Richard Schultz

mobili da esterno / outdoor furniture

1966 Collection





1966-25



1966-45





1966-28



1966-41

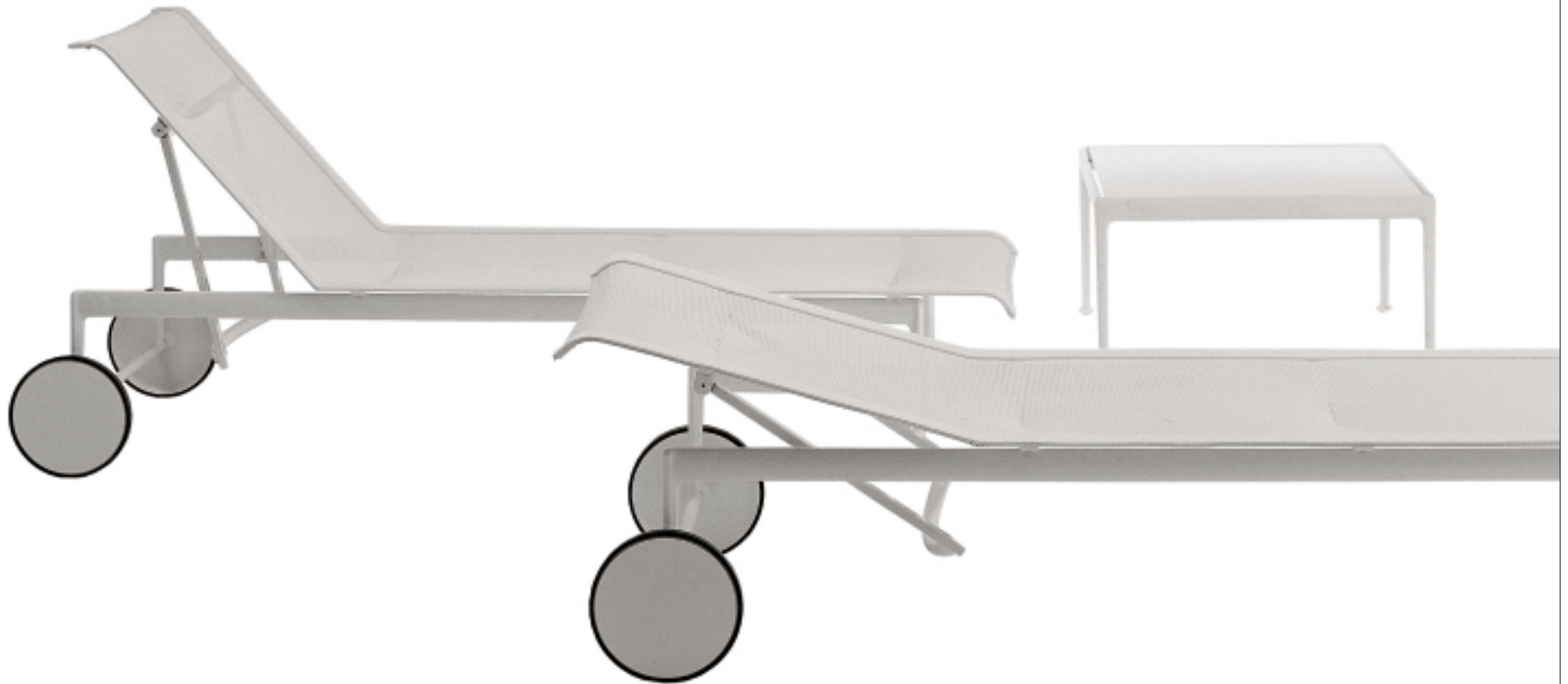

1966-42

1966-21



La collezione di sedute e tavoli per esterno disegnata da Richard Schultz nel 1966 rimane un progetto tra i più significativi della scena internazionale che B&B Italia ha voluto diffondere sul mercato internazionale.

Le finiture sono garantite per la massima resistenza agli agenti atmosferici e all'inquinamento, ai graffi e al peeling. La collezione è distribuita nelle Americhe da Richard Schultz.

The collection of outdoor seating and tables designed by Richard Schultz in 1966 is still one of the most meaningful series on the international scene. And it is the collection that B&B Italia is distributing on the

market. The finishes are guaranteed to offer maximum resistance to weather, pollution, scratching and peeling. The collection is distributed in North and South America by Richard Schultz.

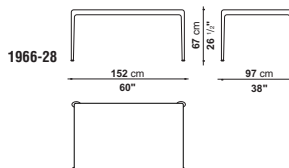
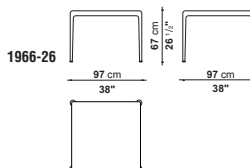
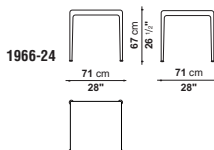
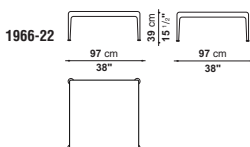
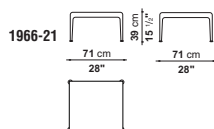
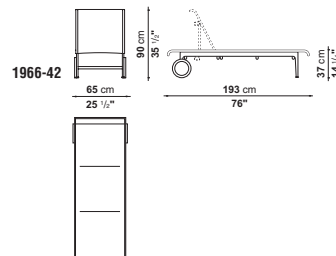
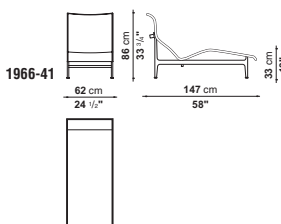
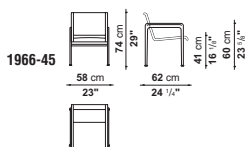
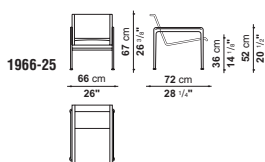

Struttura
Finitura struttura

Elementi di seduta

Bordi

Ferramenta assemblaggio
Piano tavoli

Puntali

fusione ed estrusi di alluminio
verniciatura a polveri
epopoliestere per esterni
rete di fibra poliester
impregnata con polivinilcloruro
(PVC) stabilizzato per esterni
polivinilcloruro stabilizzato
per esterni
acciaio inossidabile
lamiera d'acciaio porcellanato
bianco
materiale termoplastico

Frame
Frame finish

Seats

Edges

Assembly parts
Table top

Ferrules

die-cast and extruded aluminium
outdoor epoxy polyester
powder coating
polyester mesh impregnated
with treated polyvinyl chloride
(PVC) for outdoor use
treated polyvinyl chloride for
outdoor use
stainless steel
white glazed steel
thermoplastic material

1966 Collection, design Richard Schultz

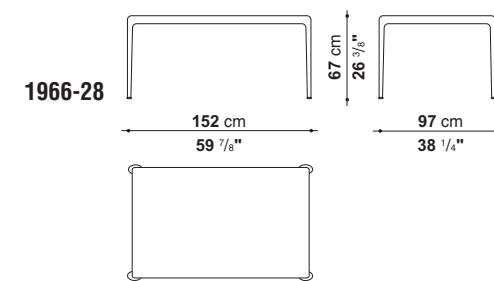
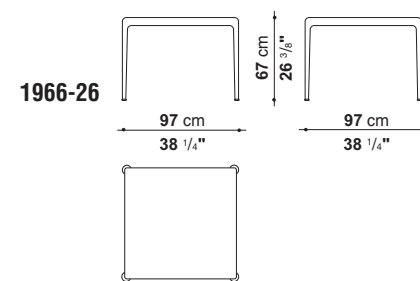
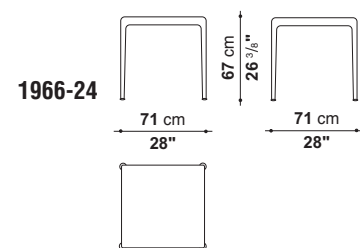
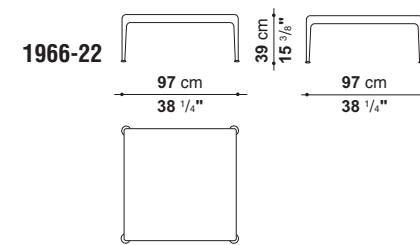
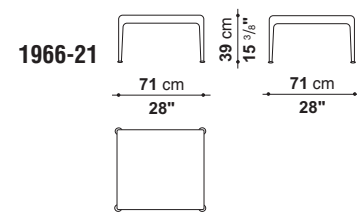
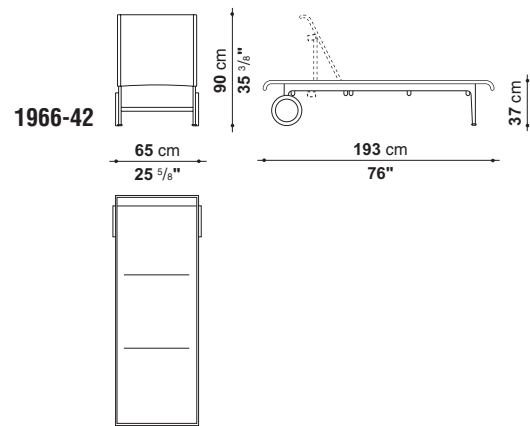
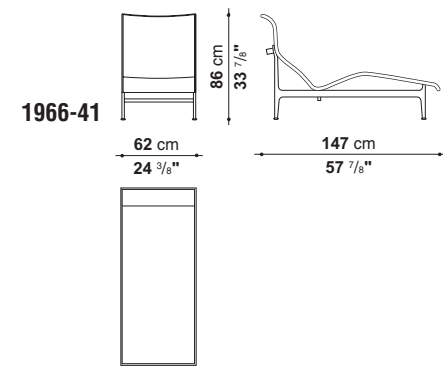
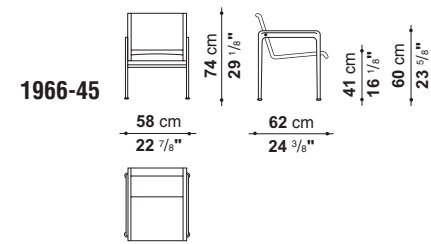
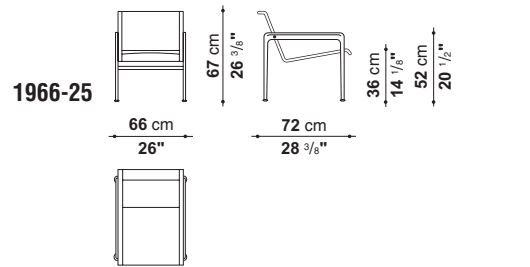
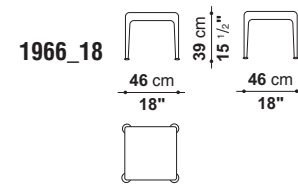
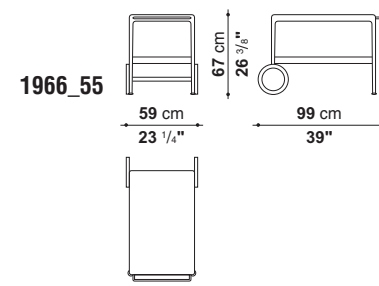
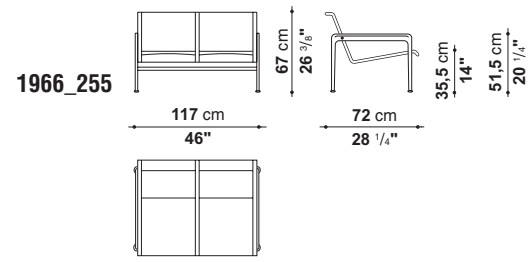

Swell Seating Collection, design Richard Schultz

